

Smart String Inverter

SUN2000-60KTL-M0



Smart

- 12 strings intelligent monitoring and fast trouble-shooting
- Power Line Communication (PLC) supported
- Smart I-V Curve Diagnosis supported

Efficient

- Max. efficiency 98.9%, European efficiency 98.7% (@480 V)
- Max. efficiency 98.7%, European efficiency 98.5% (@380 V / 400 V)
- 6 MPPT per unit, effectively reducing string mismatch

Safe

- DC switch integrated, safe and convenient for maintenance
- Residual Current Monitoring Unit (RCMU) integrated
- Fuse free design

Reliable

- Natural cooling technology
- Protection degree of IP65
- Type II surge arresters for both DC and AC

Smart String Inverter (SUN2000-60KTL-M0)



Technical Specifications	SUN2000-60KTL-M0
Efficiency	
Max. Efficiency	98.9% @480 V; 98.7% @380 V / 400 V
European Efficiency	98.7% @480 V; 98.5% @380 V / 400 V
Input	
Max. Input Voltage	1,100 V
Max. Current per MPPT	22 A
Max. Short Circuit Current per MPPT	30 A
Start Voltage	200 V
MPPT Operating Voltage Range	200 V ~ 1,000 V
Rated Input Voltage	600 V @380 Vac / 400 Vac; 720 V @480 Vac
Number of Inputs	12
Number of MPP Trackers	6
Output	
Rated AC Active Power	60,000 W
Max. AC Apparent Power	66,000 VA
Max. AC Active Power (cosφ=1)	66,000 W
Rated Output Voltage	220 V / 380 V, 230 V / 400 V, default 3W + N + PE; 3W + PE optional in settings; 277 V / 480 V, 3W + PE
Rated AC Grid Frequency	50 Hz / 60 Hz
Rated Output Current	91.2 A @380 V, 86.7 A @400 V, 72.2 A @480 V
Max. Output Current	100 A @380 V, 95.3 A @400 V, 79.4 A @480 V
Adjustable Power Factor Range	0.8 LG ... 0.8 LD
Max. Total Harmonic Distortion	< 3%
Protection	
Input-side Disconnection Device	Yes
Anti-Islanding Protection	Yes
AC Overcurrent Protection	Yes
DC Reverse-Polarity Protection	Yes
PV-array String Fault Monitoring	Yes
DC Surge Arrester	Type II
AC Surge Arrester	Type II
DC Insulation Resistance Detection	Yes
Residual Current Monitoring Unit	Yes
Communication	
Display	LED Indicators, Bluetooth + APP
RS485	Yes
USB	Yes
Power Line Communication (PLC)	Yes
General	
Dimensions (W x H x D)	1,075 x 555 x 300 mm (42.3 x 21.9 x 11.8 inch)
Weight (with mounting plate)	74 kg (163.1 lb.)
Operating Temperature Range	-25°C ~ 60°C (-13°F ~ 140°F)
Cooling Method	Natural Convection
Max. Operating Altitude	4,000 m (13,123 ft.)
Relative Humidity	0 ~ 100%
DC Connector	Amphenol Helios H4
AC Connector	Waterproof PG Terminal + Terminal Clamp
Protection Degree	IP65
Topology	Transformerless
Standard Compliance (more available upon request)	
Certificate	EN 62109-1/-2, IEC 62109-1/-2, EN 50530, IEC 62116, IEC 60068, IEC 61683
Grid Code	IEC 61727, VDE-AR-N4105, VDE 0126-1-1, BDEW, VDE 4120, UTE C 15-712-1, CEI 0-16, CEI 0-21, RD 661, RD 1699, P.O. 12.3, RD 413, EN-50438-Turkey, EN-50438-Ireland, C10/11

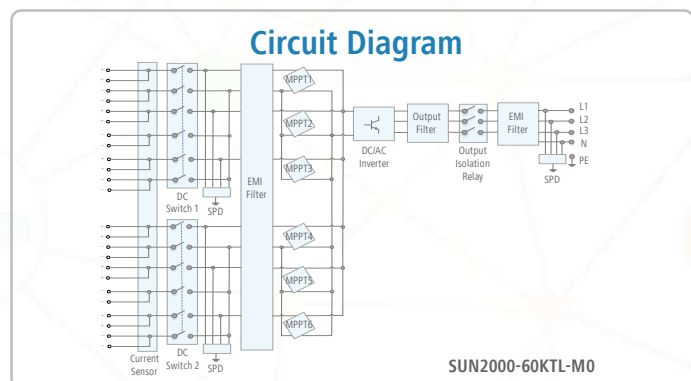
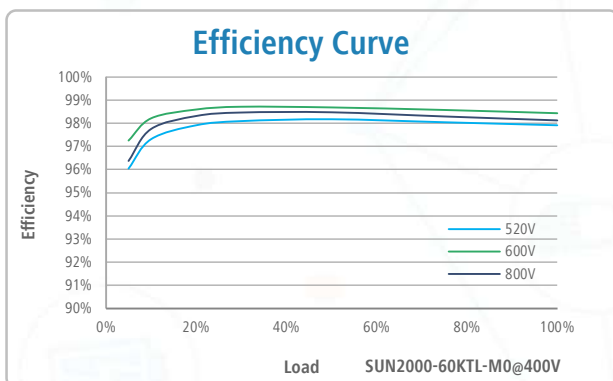

The text and figures reflect the current technical state at the time of printing. Subject to technical changes. Errors and omissions excepted. Huawei assumes no liability for mistakes or printing errors. For more information, please visit solar.huawei.com. Version No.:01-(201807)